



Kest ProFlow Mixer

The best mixer we ever built for critical pharma and biotechnology applications.

DS-000012 EN REV A

Kest ProFlow Mixer

The Kest ProFlow Mixer line is a new generation of aseptic magnetic coupled mixers. With its state of the art mixing performance and ability to mix to the last drop, it is a perfect choice for critical pharma and biotech applications.

The Kest ProFlow range covers mixing volumes up to 1200 liters and is designed for CIP/SIP applications.

With our advanced Speed Sensor technology, you will have a reliable process control with real time monitoring.

The Drive Unit is fan-less and totally enclosed in a hygienic cover - perfectly adapted to a clean room environment.

The ProFlow DC motor has an efficiency >95% thanks to and advanced integrated control circuit. The Pro Flow will minimize energy consumption and save both money and environment.

The unique brushless DC motor eliminates the need of a frequency converter to control the motor speed.

The Kest ProFlow range can be customized to perfectly fit your needs. We offer a wide range of materials and retrofit options, please contact your reseller for a quote.

Kest Mixer range for various mixing applications

Kest has developed several product lines for various mixing applications and clean room needs. The KM product line was developed for a large volume range and the Rapid

Motion (RM) line for medium shear force generation. See separate data sheets on the other product lines in the Kest Mixer family or contact your reseller for more information.

We bring flow to your mixing process

Our mixers and components have one purpose: to make your mixing process flow. 24/7. To ensure predictable and compliant results. To minimize maintenance. To minimize waste. To minimize energy use. To maximize the value created by your mixing process.



✓ **Perfect mixing result**
After years of experience developing mixers this mixer will deliver a perfect mixing result over and over again.

✓ **ZERO particle shedding**
The robust bearing combination of Zirconium and Sic and the fine-tuned geometry, ensures no particle generation. *

✓ **Sustainable**
The advanced motor boosts an impressive energy efficiency of >95%. While saving money, it also helps to reduce your carbon footprint significantly and due to low heat generation there is no need for compensating cooling - this is what we call - Green Mixing.

✓ **Full integrity of the tank**
The magnetic coupling between the mixing head and drive unit ensures total integrity of the tank. All tank plates are FEM analyzed according to PED & ASME.

✓ **Enhance your workplace**
Due to the design of the drive unit it is extremely silent during operation enhancing the environment for the operators.

✓ **Mixing to the last drop**
The wings fixed position close to the tank bottom and the possibility to run the mixer during emptying of the tank, ensures full product recovery.

✓ **Cleanroom optimized**
The drive unit does not contain any fans that will interfere with your laminar air flow. It is totally capsuled in a smooth hygienic cover that that is easy to keep clean.

✓ **Minimal heat transfer**
Thanks to the advanced drive unit, the energy is converted to rotation speed and a minimum result in heat. This prevents that heat is transferred into your application.

✓ **Integrated speed sensor**
The mixer is equipped with an integrated speed sensor that measures the speed of the mixing head, that the mixing head is in place and that it rotates in the right direction.

✓ **Minimize downtime**
The low weight of the drive unit and our patented Kest-Lock connection ensures quick disconnection from the tank plate during maintenance.

General information

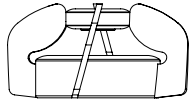

Mixing Head



Male Post

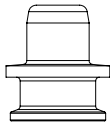

Tank Plate

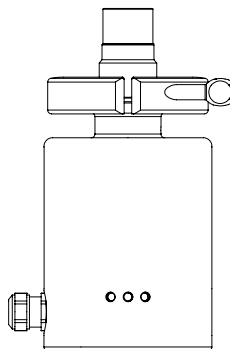

Drive Unit

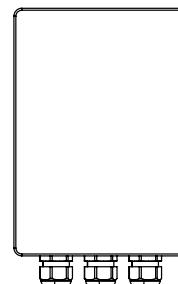

Power & logic box

The Kest ProFlow Mixer is a magnetically coupled mixer containing 4 modules, Mixing head, Male Post, Tank plate and Drive Unit.

To secure the integrity of the tank, the tank plate is welded into the tank, the mixing head and drive unit couples through the wall of the tank plate with magnetic forces. Welding tools and a welding guideline is available for easy and safe installation of the tank plate.

To select the appropriate model, use the selection guide in this datasheet. For complex mixing applications contact your reseller for consultation.

The Power and Logic box contains the logic unit safely mounted in a cabinet. The box comes with size 20/70 and 70/120, the smaller units have the logic integrated in the drive unit.

Table of Content

We bring flow	Page 2
General information	Page 3
Dimensions	Page 4
Specifications	Page 5
Weights	Page 5
Drive unit specifications	Page 6

Power & Logic box	Page 8
SpeedSensor	Page 9
Control Unit Mixer, CUM	Page 10
Selection guide	Page 11
Order information	Page 14

Dimensions

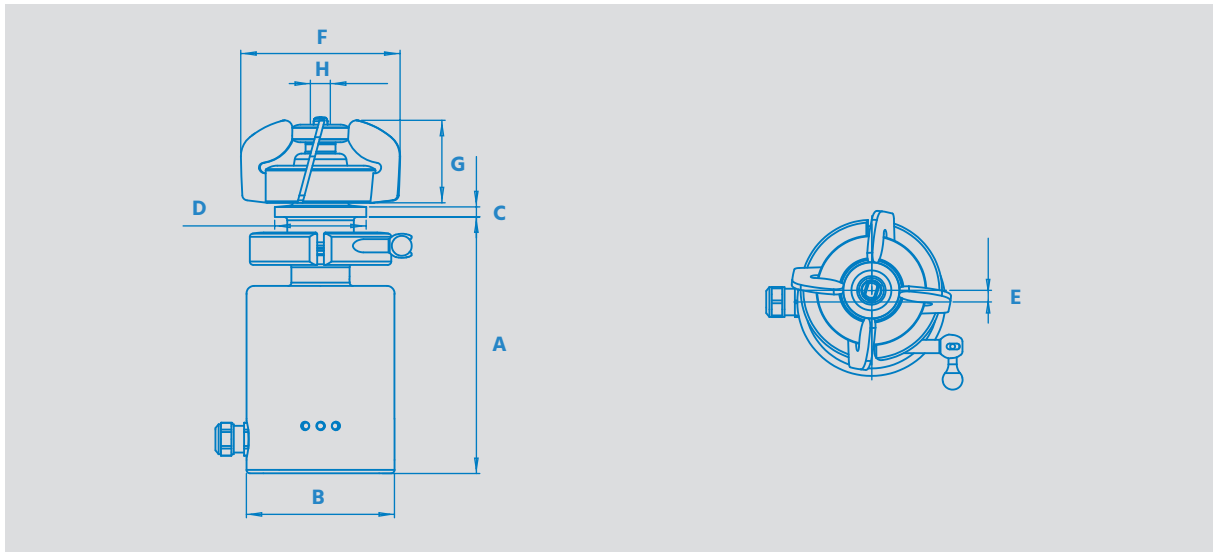

SIZE	A mm [in]	B mm [in]	C mm [in]	D mm [in]	E mm [in]	F mm [in]	G mm [in]	H mm [in]
0/3	155 [6.102]	89 [3.504]	6 [0.236]	55 [2.165]	7 [0.276]	82 [3.228]	33 [1.299]	12 [0.472]
3/7	225 [8.858]	89 [3.504]	6 [0.236]	55 [2.165]	7 [0.276]	96 [3.780]	46 [1.811]	12 [0.472]
7/20	241 [9.488]	89 [3.504]	6 [0.236]	84 [3.307]	7 [0.276]	120 [4.724]	56 [2.205]	16 [0.630]
20/70	275 [10.827]	102 [4.016]	7,94 [0.236]	89 [3.504]	- [-]	142 [5.591]	71 [2.795]	20 [0.787]
70/120	282 [11.102]	102 [4.016]	8 [0.236]	99 [3.898]	- [-]	160 [6.299]	71 [2.795]	20 [0.787]

Note! You can download 3D models of all our mixers from our CAD library at www.kest.se

Specifications

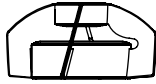

Mixing Head



Male Post



Tank Plate

MECHANICAL SPECIFICATIONS

	Mixer head	Male post	Tank plate
Material grade	EN 1.4435/ASTM 316L, Silicone carbide (SiC)	Zirconium Oxide (ZrO2)	EN 1.4435/ASTM 316L
Material requirement	EN 10 272/10028-7, A479/A240 or SA479 SA240		
Documentation	Heat Certificate 3.1 acc. to EN 10 204		
Surface finish	Ra≤0.5 µm on surfaces in product contact, Mixer Head manually polished + electro polished		
Design Temperature	[0°C to +150°C] [+32°F to +302°F]		
Operating temperature	[0°C to +135°C] [+32°F to +275°F]		
Design Pressure	[-1 bar(g) to + 7 bar(g)] [-14.5 psi to +101.5 psi]		
pH range	1-14		
Marking	Head and Bearing is marked with ID No. Tank plate is marked with material grade and heat number		
Packing	Each item is sealed in vacuum plastic bag, labelled with article code and packed in a box		
Male bearing sealing	EPDM, Silicone or Kalrez, approved acc. FDA regulation CFR 177.2600, USP Class VI		
Quality Assurance	Each product is controlled and tested acc. to Kest Technology quality assurance system		

Weights

SIZE	MIXING HEAD kg / [lb]	MALE POST kg / [lb]	TANK PLATE kg / [lb]	DRIVE UNIT* kg / [lb]	TOTAL* kg / [lb]
0/3	0.3 / [0.7]	0.02 / [0.04]	0.2 / [0.5]	2.5 / [5.5]	3.0 / [6.6]
3/7	0.5 / [1.1]	0.02 / [0.04]	0.3 / [0.7]	3.0 / [6.6]	3.8 / [8.4]
7/20	1.0 / [2.2]	0.04 / [0.09]	0.5 / [1.1]	3.5 / [7.7]	5.0 / [11.0]
20/70	1.5 / [3.3]	0.09 / [0.2]	0.8 / [1.8]	5.4 / [11.9]	7.8 / [17.2]
70/120	2.0 / [4.4]	0.09 / [0.2]	1.1 / [2.4]	5.6 / [12.3]	8.8 / [19.4]

Drive unit specifications

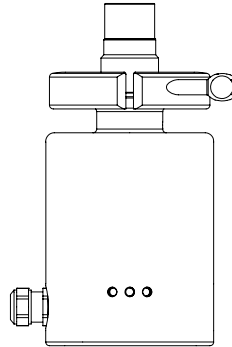

SIZE	MODEL	MOTOR POWER [W]	VOLTAGE DC [V]	CURRENT [A]	GEAR BOX RATIO[1]	SPEED RANGE [RPM]
0/3	KMPF-DU0/3A-0	63	24	3.5	-	50-680
3/7	KMPF-DU3/7A-0	63	24	3.5	1:6	50-490
7/20	KMPF-DU7/20A-0	63	24	3.5	1:6	50-490
20/70	KMPF-DU20/70A-0	754	48	18	1:5	50-490
70/120	KMPF-DU70/120A-0	754	48	18	1:5	50-490

DRIVE UNIT SPECIFICATIONS

Motor	Brushless DC
Design Temperature	[0°C to +40°C] [+32°F to +104°F]
Protection class	IP 65
Capsulation	EN 1.4404, Ra < 0.8 µm, POM (bottom lid and Speed Sensor holder)
Cable	* 3 meter multi wire, open cable end (see drive unit terminal connection configuration) ** 5 meter multi wire between drive unit and power & logic box
LED on housing	Green: Power, Yellow: Rotation, Blue: Pulse
Marking	Each item is marked with article code
Packing	Each item is sealed in plastic bag, labelled with article code and packed in a box
Quality Assurance	Each product is controlled and tested acc. to Kest Technology quality assurance system

* For size 0/3, 3/7, 7/20

**For size 20/70, 70/120

Drive unit, terminal connection (standard)

If you have chosen to run the mixer with the Kest control unit the wiring on the motor terminal needs to be changed according to table Drive unit, terminal connection (for Control Unit Mixer - CUM).

TERMINAL ID	COLOR / BASIC CONNECTION	DESCRIPTION	TYPICAL FUNCTION
X1:1	Blue / Yes	Supply ground	- Ground
X1:2	Brown / Yes	Logic supply voltage	+ 24VDC
X2:1	Purple / Yes	Logic ground	- Ground
X2:2	Black / Yes	Control input C - hardware enable	+ 24VDC closing switch (rotation start)
X3:1	- / -	-	-
X3:2	Pink / Yes	0...10V - Speed control set value input	0-10V variable speed control
X4:1	Grey / If required	10V DC output	10V supply for speed control
X4:2	White / If required	0...10V - analog speed value output	For converter or display
X5:1	Red / Yes	Speed sensor pulse signal (PNP)	For pulse converter or display
X5:2	Orange / If required	24V PNP closing contact rotation indication	PLC

Drive unit, terminal connection (for Control Unit Mixer - CUM)

TERMINAL ID	COLOR / BASIC CONNECTION	DESCRIPTION	TYPICAL FUNCTION
X1:1	Blue / Yes	Supply ground	- Ground
X1:2	Brown / Yes	Logic supply voltage	+ 24VDC
X2:1	Purple / Yes	Logic ground	- Ground
X2:2	Black / Yes	Control input C - hardware enable	+ 24VDC closing switch (rotation start)
X3:1	Gray / Yes	Motor Speed puls to control unit	Pulse
X3:2	Pink / Yes	0...10V - Speed control set value input	0-10V variable speed control
X4:1	White / If required	10V DC output	10V supply for speed control
X4:2	- / -	-	-
X5:1	Red / Yes	Speed sensor pulse signal (PNP)	For pulse converter or display
X5:2	Orange / If required	24V PNP closing contact rotation indication	PLC

Power & Logic box

POWER & LOGIC BOX SPECIFICATIONS

Material	ABS
Design Temperature	[0°C to +40°C] [+32°F to +104°F]
Protection class	IP 66
Measurement	230 x 300 x 111 mm
Marking	Each item is marked with article code
Packing	Each item is sealed in plastic bag, labelled with article code and packed in a box
Quality Assurance	Each product is controlled and tested acc. to Kest Technology quality assurance system

Power & Logic box connection terminal

TERMINAL ID	COLOR / BASIC CONNECTION	DESCRIPTION	TYPICAL FUNCTION
+48V		Supply	+ 48VDC
-0V		Supply	- 0VDC
Ground		Supply ground	- Ground
Y100:1			
Y100:2			
Y100:3			
Y100:4		Logic supply voltage	+ 24VDC
Y100:5		Logic ground	+ 24VDC
Y100:6			
Y100:7		Control input - hardware enable	+ 24VDC closing switch (rotation start)
Y100:8			
Y100:9			
Y100:10			
Y100:11		0...10V - Speed control set value input	0-10V variable speed control
Y100:12		Logic ground	0-10V
Y100:13		Speed sensor pulse signal (PNP)	For pulse converter or display
Y100:14		24V PNP closing contact rotation indication	PLC
Y100:15		10V DC output	+ 10VDC supply for speed control
Y100:16		24V DC output	+ 24VDC supply for closing switch

Speed Sensor

The Kest Mixer speed sensor unit is a integrated sensor system that enables secure verification of the actual rotation of the mixer head inside the tank.

An integrated function in the Kest Mixers speed sensor also verifies that the mixer head is in place in the tank and that it is rotating in the correct direction, "clockwise".

The unit consists of a sensor, that is located underneath the magnetic rotor, and a converter unit integrated in the drive unit circuit board.

The output signal from the sensor is 1 pulse/rotation as standard, 1 pulse/magnet can be delivered upon request.

For visual indication of the different functions, the speed sensor is connected to the LED's located on the drive unit enclosure:

- **Green LED: Power (steady light)**
- **Yellow LED: Rotation (steady light)**
- **Blue LED: Pulse (pulsing light)**

The sensor and cable are designed for +150°C to withstand the temperatures in the tank plate during sterilization.

MECHANICAL SPECIFICATIONS

	Sensor holder	Cabling
Material grade	POM C	Teflon-FEP
Design Temperature	[0°C to +150°C] [+32°F to +302°F]	
Packing	The Speed sensor is installed on the drive unit before delivery	
Quality Assurance	Each product is controlled and tested acc. to Kest Technology quality assurance system	

Electrical Specifications

Type	Hall effect switch, PNP closing circuit	
Voltage	8-30 V DC	
Rated Current	200 mA	

Model	Standard pulse	Max pulses (on request)
KMS-0/3	1 pulse / rotation	2 pulses / rotation
KMS-3/7	1 pulse / rotation	3 pulses / rotation
KMS-7/20	1 pulse / rotation	3 pulses / rotation
KMS-20/70	1 pulse / rotation	4 pulses / rotation
KMS-70/120	1 pulse / rotation	5 pulses / rotation

Control Unit Mixer, CUM (optional)

The Kest control unit is developed for the DC drive units to control and monitor the rotation speed of the mixer.

The Kest control unit is powered with 100-240 VAC at 50-60Hz that is transformed to 24 VDC, feeding the mixer.

The three pre-set buttons is used as quick buttons to set a certain speed value, each can be programmed to a specific RPM.

The unit is pre-programmed with ramping parameters for acceleration and deceleration to prevent the mixer from damage.

The display shows the rotation speed of the mixer and the target speed value. The display is also used when programming the pre-set buttons and for delivering error messages.

If you forgot to mount the mixing head in the tank it will show an error message.

The control unit is compatible with size 0/3, 3/7 and 7/20.

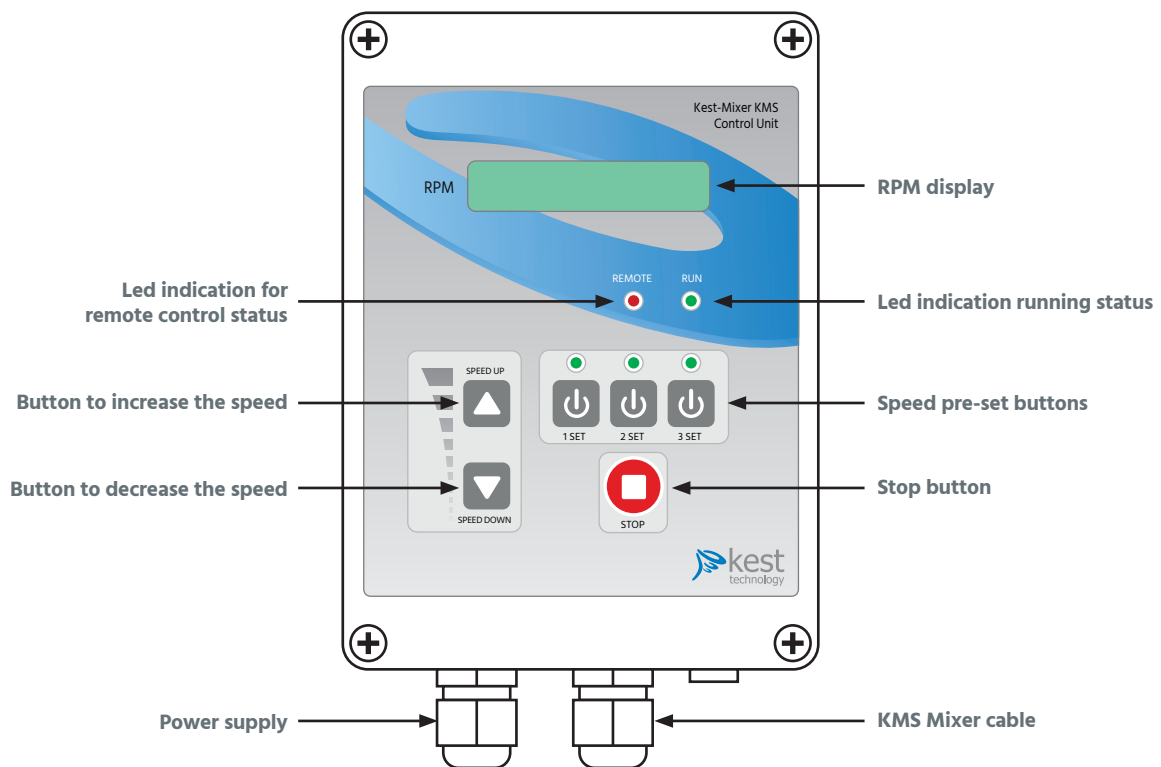

SPECIFICATIONS

Cabinet	
Material grade	Grey ABS
Measurement (HxWxD) mm	175 x 125 x 75 mm [6.890 x 4.921 x 2.953 in]
Design Temperature	[0°C to +40°C] [+32°F to +104°F]
Packing	Each item is sealed in plastic bag, labelled with article code and packed in a box
Quality Assurance	Each product is controlled and tested acc. to Kest Technology quality assurance system
Electrical Specifications	
Power supply	100 - 240 VAC / 50-60 Hz
Effect	30 W
Protection class	IP40

Selection guide

The mixer is selected after volume and desired mixing type based on the viscosity of the media. The different mixer sizes are targeting a specific volume range based on viscosity of 1 cP. Depending on the viscosity you might need to go for a larger size even if you are in the target volume. The characteristics of the General, Gentle and Vigorous mixing is subjective and built on experience. See example in the end of the selection guide on how to select correct mixer size.

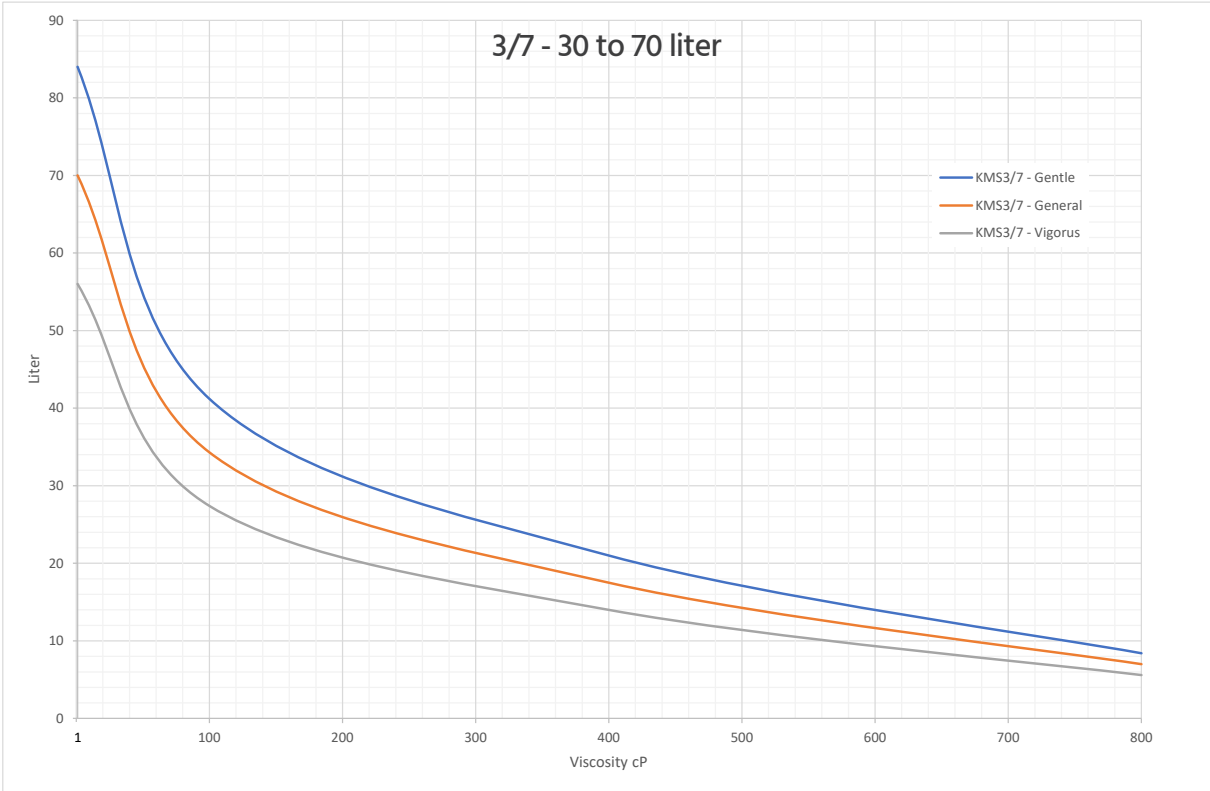
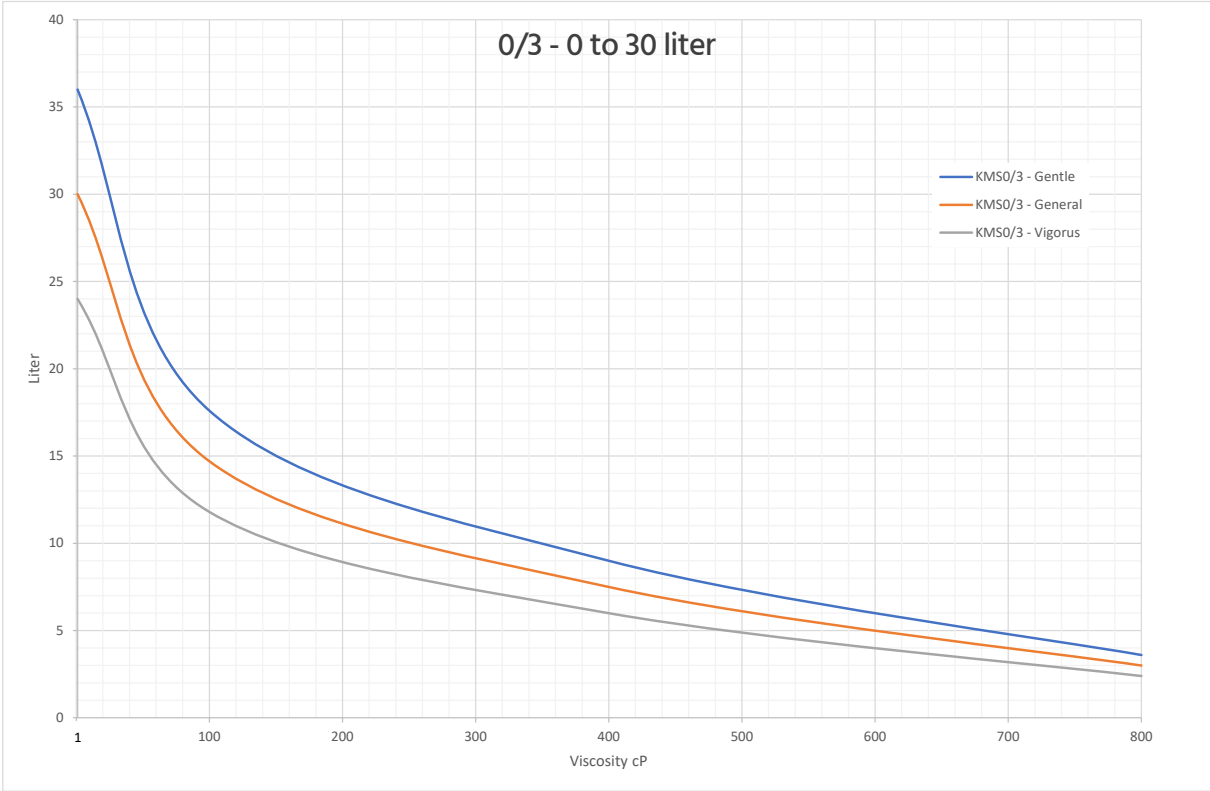

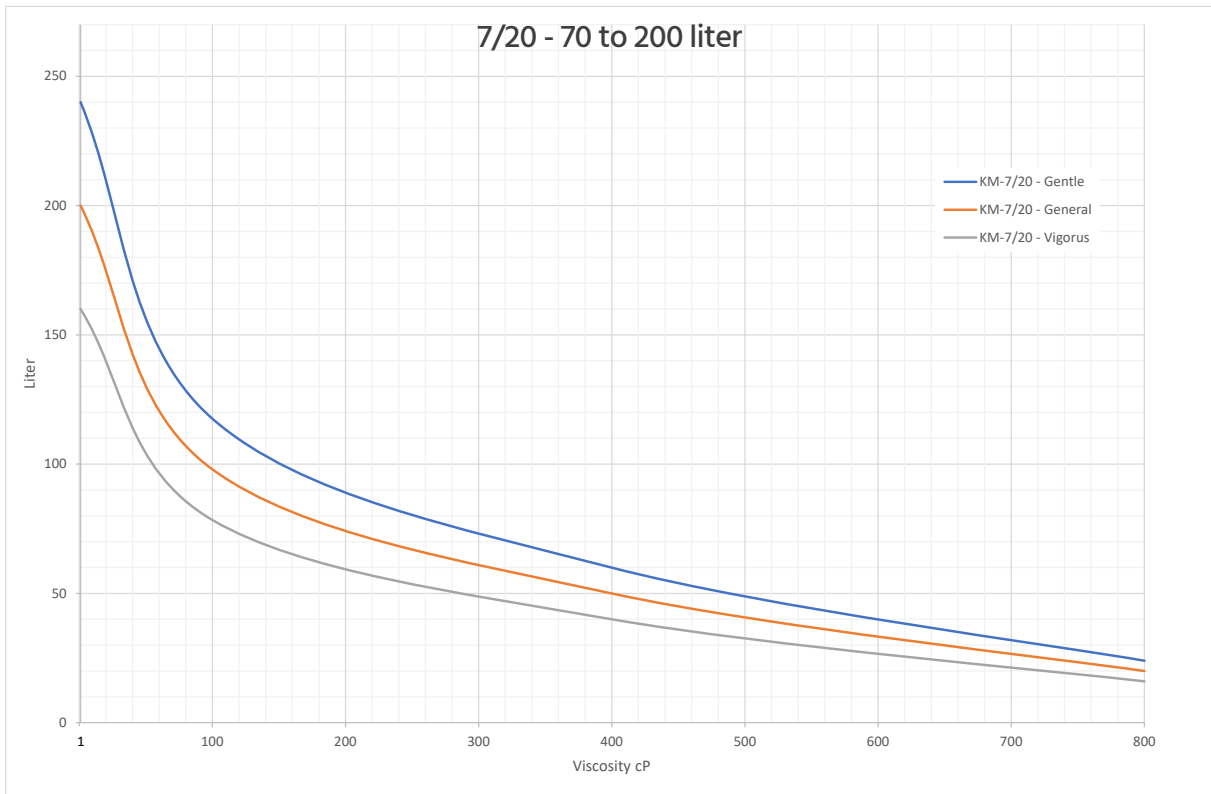

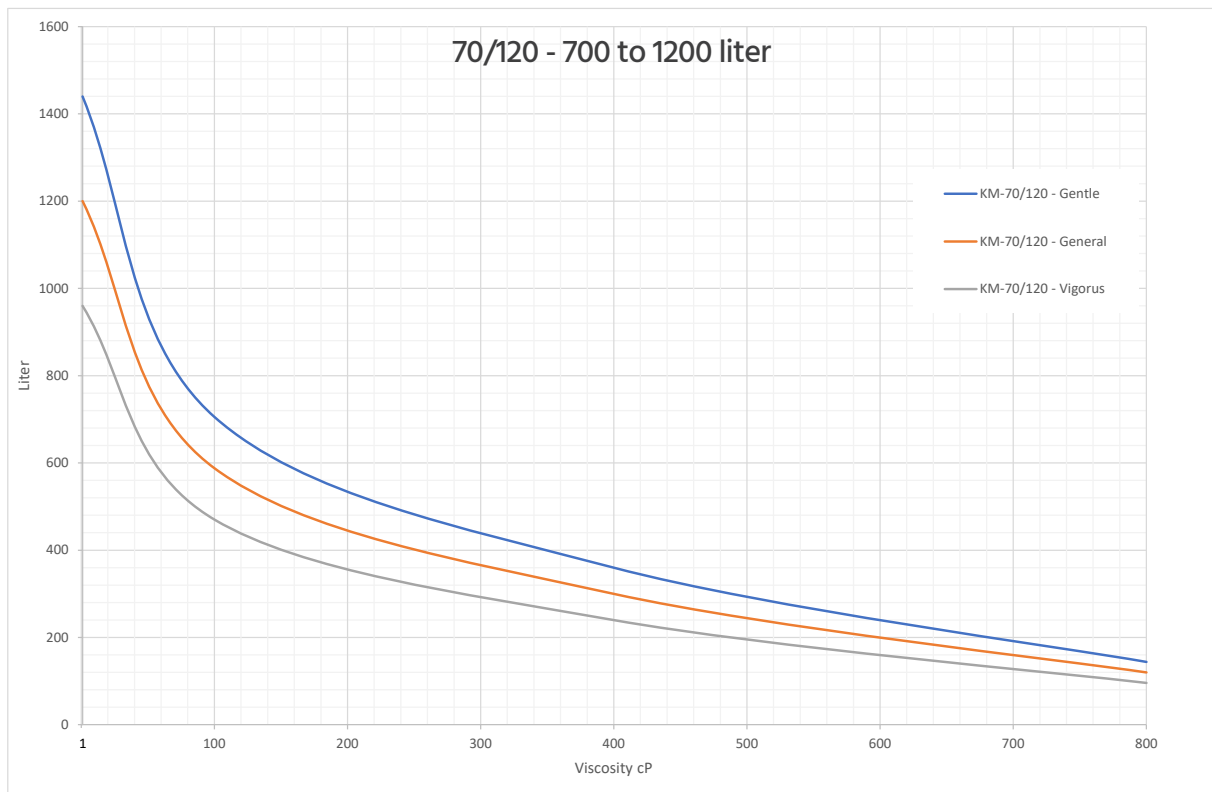

Example:

You want to select a mixer that shall generate General mixing

The max mixing volume is 30 liters

The viscosity of the media is 100 cP.

Size 0/3 has the range of 0-30 liter at 1 cP, but since the viscosity is 100 cP the capacity for General mixing is decreased to around 15 liters, see 0/3 graph at 100cP, orange line.

The next size is 3/7 with a range of 30-70 liter at 1 cP. That mixer can handle 34 liters of media at viscosity 100 cP, see 3/7 graph at 100cP, orange line.

For this application you need size 3/7.

For higher viscosities you might need to go up several sizes to find a mixer with the sufficient volume capacity.

Test center

Mixing can be simple and complex, this selection guide sizes the mixer to the correct capacity. Mixing performance can be affected by many different factors, if you need support with your mixing application, we have long experience and an inhouse fully equipped test center. Do not hesitate to contact us with your mixing application.

Kest Mixer ProFlow (KMPF), Ref.No list

SIZE	MIXING HEAD	MALE POST	TANK PLATE	DRIVE UNIT	MULTICABLE*
0/3	102440	100562	100383	102691	101290
3/7	102441	100562	100625	102692	101290
7/20	102442	101530	100647	102963	101290
20/70	102443	100415	100396	102673	102694
70/120	102444	100415	102629	102674	102694

*The multicable article is setup as 1 meter (3.3 ft), when ordering you specify the length of the cable you need by adding articles. If you order 3 articles you will get a 3 meter cable. For the 20/70 and the 70/120 the cable length specified is between the motor and the power and logic box. If you don't specify anything your mixer will be shipped with the standard cable length, see drive unit specification.

Kest Mixer ProFlow (KMPF), options - Ref.No list

SIZE	CONTROL CABINET	ATTRACTOR*	MULTI TOOL*	WELDING TOOL
0/3	100669	101620	101006	100446
3/7	102373	101620	101006	100923
7/20	102373	101436	101342	100802
20/70	-	100571	100655	100802
70/120	-	-	100655	100780

*See separate data sheet