

# Operating and Installation Instructions

## Quattroflow 150S Quaternary Pump Stainless Steel 4-Piston-Diaphragm Pump (Multiple-Use)



Models with or without control panel and housing; other versions are possible.

Please read this manual carefully before start-up of the pump and take care of an appropriate instruction of the operating staff.

**Attention!**  
**Please regard the warning and safety advices!**

Original Instruction



## Contents

1. General .....	3
1.1. Introduction .....	3
1.2. Storage .....	3
1.3. Labelling of the pump .....	3
2. Description of the QF 150S pump .....	4
2.1. Appropriate use .....	4
2.2. General description of the machine .....	4
2.3. Start-up .....	5
2.4. Control panel .....	6
2.5. QControl .....	6
2.6. Cleaning (CIP) .....	6
2.7. Autoclave .....	7
2.8. Steaming in place (SIP) .....	7
3. Safety .....	8
3.1. Labels at the pump .....	8
3.2. Qualification of the personell .....	8
3.3. Responsible working .....	8
3.4. Dangers in case of noncompliance with the safety instructions .....	8
3.5. Safety hints for the operator .....	8
3.6. Safety instructions for maintenance, inspection and mounting operations .....	9
3.7. Unauthorized reconstruction and spare part usage .....	9
3.8. Inadmissible modes of operation .....	9
3.9. Further warning and safety instructions .....	10
4. Maintenance/Serviceing of the QF 150S .....	12
4.1. Replacement of diaphragm, valves and o-rings .....	14
4.1.1. Disassembly of the pump chamber .....	14
4.1.2. Exchange of the elastomer parts .....	14
4.1.3. Assembly of the pump chamber to the ring drive .....	15
4.2. Replacement bearing unit .....	16
5. Operating troubles, causes and remedial action (Troubleshooting) .....	17
6. Performance charts of the QF 150S .....	18
7. Technical data of the QF 150S .....	19

# 1. General

## 1.1. Introduction

These operating instructions are valid for the Quattroflow 150S pump.

No liability will be undertaken for any damages caused by non-compliance with the operating instructions and service conditions! Original spare parts serve safety purposes. The use of other parts may cancel the liability for the consequences and secondary failures resulting thereof.

Manufacturer: PSG Germany GmbH  
Hochstraße 150-152  
47228 Duisburg, Germany  
Phone: +49 (0) 2065 89205-0  
Fax: +49 (0) 2065 89205-40  
e-mail: [psg-germany@psgdover.com](mailto:psg-germany@psgdover.com)  
Internet: [www.quattroflow.com](http://www.quattroflow.com)

Quattroflow quaternary diaphragm pumps are constructed according to the state of the art and they are reliable. Imminent danger by operating error or misuse can lead to damages of properties and/or persons. The pumps are to be applied for the intended use and in a safety-related proper condition only.

## 1.2. Storage

In general the Quattroflow pump is delivered operational and packaged. If the unit is not installed right away, proper storage conditions are important for a trouble free operation later. The pump has to be protected from wetness, coldness, dirtying, UV-radiation and mechanical influences. The following storage conditions are recommended:

- Steady ventilated, dust and vibration free storage room
- Prevention of direct thermal influences (sun, heating)

## 1.3. Labelling of the pump

The PSG Germany GmbH is certified as a modern, quality-orientated enterprise according to DIN EN ISO 9001:2015 and 14001:2015. Before release for dispatch, any Quattroflow pump has to undergo an extended final control. The performance data registered during this are archived in our records and can be read back at any time.

As a general rule in the countries of the EU only such machines are allowed to take into operation, which are determined to meet the regulations of the EU machinery directive, the harmonized standards, European standards and the respective national standards. Hence the operator has to verify whether the Quattroflow pump manufactured and delivered properly according to the customers order meets the mentioned requirements.

Therefore make sure, before putting the pump into operation, that the pump and the used materials of construction are suitable for the provided application and the installation site.

The type label of each Quattroflow pump can be seen on the bottom of the base plate. Besides the serial number of the pump head is fixed at the front cover.

## 2. Description of the QF 150S pump

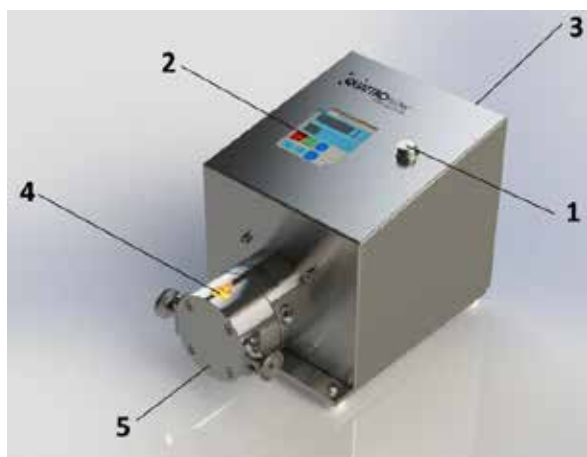

### Quattroflow 150S with 90W brushless DC motor in a stainless steel housing

- 1.) Power switch
- 2.) Control panel
- 3.) power cord, type label
- 4.) Safety label: "6 bar!" Do not remove!
- 5.) Serial no.

### 2.1. Appropriate use

The Quattroflow 150S is a 4-piston Diaphragm pump, which is mainly used to pump water-like fluids that are typically handled in research-, pilot plant- or production facilities of the pharmaceutical, biotech, food or cosmetic research centers or plants.

Examples:

- Solutions containing proteins (albumin, IgG, Clotting factors, monoclonal antibodies, enzymes, vaccines.)
- Solutions of polymers or suspensions (silicon, latex, chromatography media)
- Cell suspensions (bacteria, yeast, algae, fungi, mammalian cells)
- colloidal solutions
- Suspensions of viruses or phage
- Dairy products
- Gelatine
- Supplements and ingredients for cosmetic and food

### Typical applications for the QF 150S

- Filtration technology:
  - To recirculate feed/retentate (e.g. membrane cassettes, hollow fibre, spiral wound, ceramic elements)
  - Feed pump for filter cartridges or plate and frame depth filters
- Chromatography:
  - Packing of chromatography columns
  - Feed pump to mix gradients
- Feed pump for centrifuges or separators
- Feed pump for filling machines

## 2.2. General description of the machine

The Quattroflow 150S pump is a 4-piston diaphragm pump. The four segments of the pump diaphragm oscillate back and forth. This alternate movement is created by a connector plate that is arranged on a ball bearing. The ball bearing sits on an eccentric shaft. The connector plate does not turn!

The stroke of the pistons is determined by the angle of the eccentric. There are eccentric shafts with 5° available.

Range of flow rate: 5° eccentric shaft: appr. 1 - 180 L/hr at max. 3000rpm

### **Please note:**

The direction of flow can be adjusted by turning the pump chamber in 90° steps.

The Quattroflow 150S is self-priming and can run dry. Inside the pump chamber there are no rotating parts that might cause heating up of the product or shed particles.

The pump-motor unit is mounted on a stainless steel base plate. A perpendicular mounting position is possible.

## 2.3. Start-up

Before start-up of the pump anyone should acquaint oneself with the explanations of the chapter troubleshooting (see page 16). Only by this the defect quickly can be realized and eliminated in case of trouble. Problems which cannot be solved or with an unknown reason should be passed on to the manufacturer.

Prior to each use we recommend to flush the pump with a proper fluid (e.g. water or buffer).

Prior to the very first use it might make sense to clean and sanitize the pump chamber. A commercial caustic cleaner and/or 0.1N to 0.5N NaOH can be applied. The chosen cleaning agent can be recirculated and also stored inside the pump chamber. For flushing out of any cleaning agent do not recirculate! Check with appropriate analytical methods the success of the flushing procedure..



### **Recommendation: Test run prior first use!**

Before using your pump in your process perform a test run to get used to the specific properties of the pump.

**Please note:** PSG Germany GmbH is also building custom-made pumps and set-ups. These modified pumps can be different from this one that is described in here. However the basic information is applicable to all of the Quattroflow 150S Series pumps. Please do not hesitate to contact us for further information.



**Pay attention to a sufficiently dimensioned piping. A too small piping of the suction line can cause cavitation as well as a loss of performance.**

**If hoses were used in the suction line, make sure that they do not collapse due to the negative pressure.**

**When installing the pump please consider that around the pump enough space is available for operation and maintenance. Pay attention to the required space needed for assembly and disassembly of the pump chamber (see 4.1.1.).**

**During start-up pay attention to the warning and safety instructions of the following chapter 3 of this manual.**

## 2.4. Control panel

In the Quattroflow 150S pump is operated with a 50 W brushless PANASONIC motor. You can modify the speed of the motor by the control panel on the top of the pump.

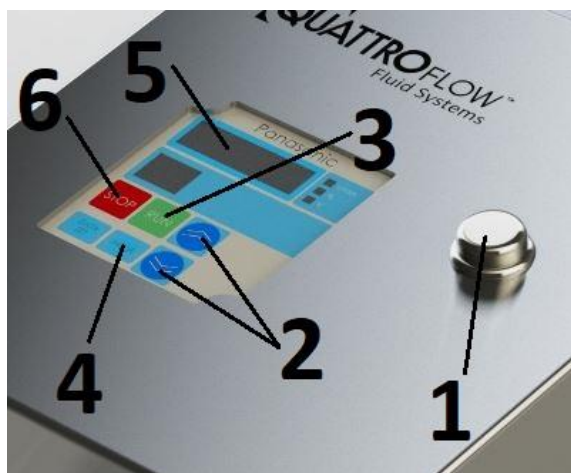

- 1.) Main switch. Push to start – the panel lights up
- 2.) Push to speed up (arrow bottom-up) or to speed down (arrow top down)
- 3.) Push "Green button" RUN, to start the pump
- 4.) "MOD button" Switch between rpm, efficiency %, motor power V
- 5.) Display show: "rpm, %, V" (max. speed 3.000 rpm)
- 6.) Push the "Red button" STOP to stop the pump

**Attention: The optimal motor parameter are set by the factory.**

**Only authorized and qualified personnel should change the parameter of the control panel!**

### ***Attention!***

**You must study the operating instructions of the PANASONIC–Motor before you make any changes of the parameter!**

## 2.5. QControl

All versions whose article code includes "QCon" are equipped with the control panel "QControl". The control panel is covered in a separate manual, therefore see the "QControl manual" for further information.

## 2.6. Cleaning (CIP)

Depending on the products in contact with the pump and given requirements the cleaning procedure needs to be adapted accordingly. It is the responsibility of the user to verify the cleaning efficiency. Safety rules and safety measures like protective glasses, gloves and protective clothing have to be followed and used when working with chemicals like sodium hydroxide (NaOH).

As a general rule we recommend to clean the pump according to the following procedure.

1. Pre rinse the pump with pure water, until residual amounts of product have been removed.
2. Cleaning step with 0.5 M NaOH (ca. 50°C) at 80% of the maximum RPM for approximately 30 min. Check before, if surrounding conditions (e.g. pipe diameter, system pressure rating) allow to operate the pump at this speed.
3. Final rinse with pure water, until neutrality has been achieved (e.g. by measuring conductivity or pH of the rinse water).

## 2.7. Autoclave

For sterilization of the pump chamber we recommend the following steps.

1. CIP of the pump chamber according to 2.5 or any other suitable process
2. Empty the pump
3. Remove the pump chamber from the pump drive (see 4.1.1)
4. Close in and outlet of the pump e.g. by connecting hoses. Ensure that a free interchange of gas and steam over a sterile barrier (e.g. sterile filter) at in- and outlet is available.
5. Autoclaving of the prepared pump chamber in a vacuum autoclave at max. 130°C (266°F) for max. 30 min. Follow instructions of the autoclave manufacturer.



Please make sure that the pump chamber is not placed on the clamp ring during the autoclave process. The clamp ring should not be loaded during autoclaving.

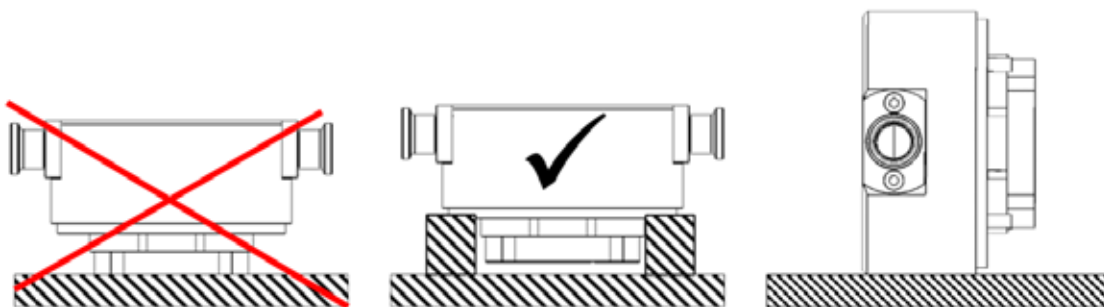

## 2.8. Steaming in place (SIP)

For steaming in place the pump chamber needs to be installed on the pump drive. During the steaming process, the temperature in the pump must not exceed 130°C (266°F) and should not last longer than 30 min. The cooling of the pump chamber should be slow against room air.



Do not operate the pump during the SIP process and cooling!

Depending on the SIP conditions it may be necessary to shorten the maintenance intervals for the elastomers significantly. Tightening torques (4 Nm, 3 lb-ft) of external bolts of the pump chamber have to be verified after each SIP cycle.

## 3. Safety

These operating instructions contain basic hints to be observed during installation, operation and maintenance. Therefore, prior to mounting and commissioning, these operating instructions must by all means be read by the fitter as well as the pertinent expert personnel/customer and must always be available at the place of installation of the pump. Not only are the general safety hints listed under this item "Safety" to be observed, but also the special safety hints in other chapters.



- **3.1. Labels at the pump**

Marking labels at the pump e.g.

- pmax 6 bar
- Fluid connections
- Direction of flow

must not be removed and has to be readable.

- **3.2. Qualification of the personell**

The customer is responsible for ensuring that all maintenance, inspection and mounting operations are performed by authorized and qualified expert personnel who have sufficiently informed themselves by thoroughly studying the operating instructions.

- **3.3. Responsible working**

Please follow strictly the safety guidelines of this manual, as well as all national and possible internal regulations (e.g. the handling of chemicals, like caustic or acid, the handling of biological materials, the handling of tubing, piping, instrumentation, fittings etc.

- **3.4. Dangers in case of noncompliance with the safety instructions**

In case of non-compliance with the safety instructions may cause danger to personnel, equipment and environment.

**It can cause for example:**

- Failure of the proper function of the pump/system
- Failure of required procedures for maintenance
- Danger to personnel by electrical, mechanical, chemical, biological impacts
- Danger to equipment and environment through leakage of dangerous substances

- **3.5. Safety hints for the operator**

- In case of hot parts (e.g. while CIP or SIP) protective measures have to be taken.
- Protecting covers of moving parts (e.g. coupling, cover of motor) must not be removed.
- Leakages of dangerous products have to be handled without any danger for persons and environment. Statutory regulations must be observed.
- Dangers by electrical energy are to be excluded (for details please refer to the regulations of the VDE and the local energy supply associations)



- **3.6. Safety instructions for maintenance, inspection and mounting operations**



- Basically, operations at the pump must be performed during standstill only. The motor has to disconnect from the power supply, e.g. by pulling out the power plug or using a repair switch, and has to secure against unintentional switch-on. This can be realized by a lockable emergency switch. To prevent an accidental re-starting a danger sign should be installed.



- The operator must ensure that all maintenance, inspection and installation work is performed by authorized and qualified skilled personnel acquainted themselves with this manual.
- Before starting to disassemble the pump, take care that the pump has been emptied, rinsed, depressurized and disconnected at all phases of the power supply. Both ports piping are to be closed and drained if applicable. If the pump is being deported from the plant, a reference about the delivered liquid has to be attached.
- Pumps or aggregates handling noxious fluids (e.g. caustic, bio hazardous) must be decontaminated. Immediately following completion of the work, all safety-relevant and protective devices must be re-installed and/or re-activated. Before putting the pump back into operation, take care of the mentioned instructions of the chapter "start-up" and check the tightness of the pump.
- Please respect the relevant additional security advices, if the pump has been used for aggressive, dangerous or toxic liquids (e.g. suitable protective equipment according to the safety data sheet of the liquid). In case of a diaphragm rupture, it is possible that residues of the liquid remain behind the diaphragms and in the area of the ring drive. Hence, appropriate safety equipment according to the safety data sheet of the liquid is indispensable.
- Especially when deliver critical liquids, wear parts, like diaphragms, should be replaced within a preventive maintenance.
- Procedure for pump return: According to the requirements of our 14001-certification, every unit which is send to PSG Germany for diagnosis or maintenance reasons has to be accompanied by a filled out decontamination-sheet. Otherwise a processing is not possible. The decontamination-sheet is enclosed to this manual. Please pay attention to the further safety regulations.

- **3.7. Unauthorized reconstruction and spare part usage**

The use of non-original Quattroflow spare parts or not authorized accessories and reconstructions lead to the lapse of the warranty immediately. When operating such a pump, damages of properties and/or persons cannot be excluded..

- **3.8. Inadmissible modes of operation**

A safety operation of the pump is ensured only by an appropriate use according to the specific data of the enclosed pump data sheet. The values limitations given in the data sheet must not be exceeded.

### • 3.9. Further warning and safety instructions

These warning hints are to prevent the user from an inadmissible mode of operation. These warning hints are to be strictly followed to avoid any damage of the pump and/or any danger to personnel



The maximum allowed discharge pressure depends on the temperature of the fluid: **p<sub>max</sub> at room temperature = 6 bar (>40°C = 4 bar) [=87 psi (>104°F = 58 psi)]**. An exceeding of the maximum allowed discharge pressure must avoid in any case (do not remove the warning sign at the pump). As a result – if only temporarily – of an exceeding of the allowed discharge pressure the diaphragm can be damaged. The resulting leakage may lead to a loss of the pumping fluid and damages of properties and/or persons. Pay attention to a sufficiently dimensioned piping on the suction and discharge line to prevent a too high pressure in the pump. The pump chamber may not be set under pressure when it is not mounted on the drive.

- The free cross section of the suction side as well as the length must be measured in such a way to avoid cavitation.
- The use of a safety device (e.g. pressure switch) can be necessary..
- Please make sure that prior to the start of the pump the discharge line is checked. Make sure that there is no flow restriction in the discharge line to avoid any over pressure (e.g. closed valve).
- Flush the pump prior to use with appropriate fluid (e.g. buffer).
- Foundation design: The foundation must be designed so that it can take the weight of the pump aggregate on the entire surface. .
- Please make sure that the pump is operated with the proper mains voltage and frequency to avoid damages and electrical danger.
- Make sure that the slots for the cooling air are not blocked.
- Due to the versatile possibilities to use the Quattroflow pump it is highly recommended to check case by case if the pump will be the right tool for the specific application. The user/operator is responsible to perform a proper method of testing if the pump should be applied for his specific application. The chemical and thermal compatibility of the elastomeric parts of the pump with the fluid that will be pumped are to be checked by the operator before the first process run. E.g. Oily, fatty fluids or solvents might cause a swelling and/or destruction of the elastomeric components. If in doubt, please contact the manufacturer!
- Operating the pump in humid or aggressive air can cause damages to the motor and control box.
- The control box should not be exposed to spray/splash water or to heat sources.
- Depending on the conditions of operation, the liquid conveyed might escape from the pump in case of a diaphragm rupture. For further safety requirements the optional equipment diaphragm monitoring is recommended.
- Pools of liquid which appear in the near outer area of the pump have to be inspected on danger potential, if necessary safety measures are to be taken.
- Chemical and biological reactions in the product chamber of the pump (mixture of different substances) and the freezing of the liquid have to be avoided.
- To avoid corrosion the contact of aggressive solutions (e.g. NaCl, HCl) with the outer stainless steel surfaces of the pump (e.g. hood, base plate) has to be prevented.
- The Quattroflow pump is a positive displacement pump and can theoretically generate an infinitely high pressure even at low speed (rpm). Prior to each start of the pump check and make sure that the discharge line is not closed or restricted. The design of the discharge line must not build up a pressure of > 6 bar (87 psi).
- If suction and/or discharge line are flexible tubing, then make sure that these tubing do have the proper pressure rating for the full range of temperatures that are applied.
- Please follow the general safety guidelines when handling chemical fluids (wear gloves and/or glasses) before the pump chamber will be opened.
- Never operate the pump without coupling protection and motor housing.



- Quattroflow pumps can lead to bruises when lifting, sinking or assembling them. Appropriate accessories and safety equipments are to be used. Big and heavy modules have to fixed and secured to lifting gears when transporting/replacing them.
- Disconnect mains before doing any maintenance! The housing of the control box or the motor is to be opened only by skilled personnel. Check the electrical cables before connecting to mains supply.
- During all maintenance work it has to be ensured that no explosive atmosphere can arise. Appropriate protection equipment is recommended. The Quattroflow 150S **must not be operated in explosion-proof areas**. Special versions for “ATEX” applications are available. Please contact the manufacturer.

**Attention! Inadmissible modes of operation, arbitrary reconstruction, spare parts production and/or any changes of the design (without admission of the manufacturer) may cancel the liability for the consequences resulting there from.**

## 4. Maintenance/Service of the QF 150S

Due to the robust construction the Quattroflow pump are widely maintenance-free. The ball bearings do not need any extra lubrication.

The diaphragms, valves and o-rings should be checked in regular intervals and if needed they has to be replaced (Service kit diaphragm-valves-o-rings: PSKITQF15MU). We recommend the following maintenance intervals for the different pump parts:

Component	Maintenance interval	Action
Elastomer parts (diaphragm, valves, o-rings)	1000 h operating hours, at least once a year*	Replacement of the elastomer parts (order no. PSKITQ15)
Shaft-bearing-cap unit	1000 h operating hours, at least once a year	Replacement of the complete unit (kit order no. PSKITWLC155)
Motor	Pay attention to the maintenance information of the manual of the motor	
Coupling	Pay attention to the maintenance information of the manual of the coupling	
Gear	Pay attention to the maintenance information of the manual of the gear	

\*Depending on the operation conditions (pressure, temperature, flow rate, SIP, etc.) it may be necessary to shorten the maintenance intervals for the elastomers significantly.

In case that the diaphragm broke it needs to be replaced. Then it is also recommended to check the ball bearings. For corrosion reasons or a clearly audible operating noise the parts of the bearing service kit should be also replaced. (PSKITWLC155). In general it is recommended to replace the elastomer parts whenever the pump chamber is opened.



**Please follow the general guidelines and safety advices when handling with chemicals.**



**Disconnect mains supply before opening the pump housing!**

Basically, operations at the pump must be performed during standstill only. The motor has to disconnect from the power supply, e.g. by pulling out the power plug or using a repair switch, and has to secure against unintentional switch-on. This can be realized by a lockable emergency switch. To prevent an accidental re-starting a danger sign should be installed..



**After purging the pump with air there might be a small residual amount of fluid inside the pump chamber. Flush the pump chamber thoroughly and check the rinse fluid.**

**The dismounting and mounting of the pump should be done on a rigid table or work bench. Please note: the pump is heavy.**

**All further warning and safety instruction of chapter 3 has to be respected.**

## 4.1. Replacement of diaphragm, valves and o-rings

The replacement of the diaphragm and the valves can be conducted by the operator. The following drawings describe it step-by-step (maintenance kit PSKITQF15MU).

In case of bursting diaphragms by overpressure we advise also to change the shaft-bearing unit (PSKITWLC155, see chapter 4.2.).

### 4.1.1. Disassembly of the pump chamber

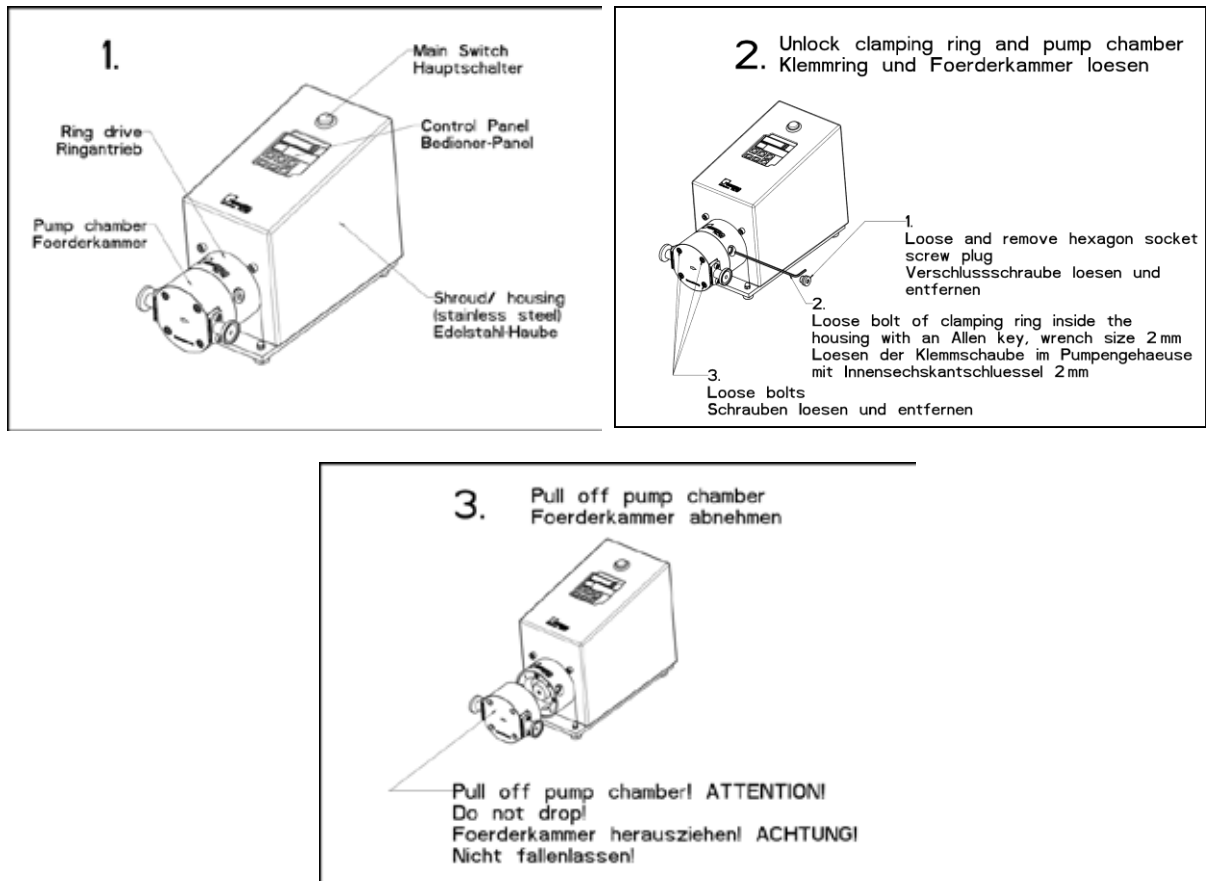

## 4.1.2. Exchange of the elastomer parts

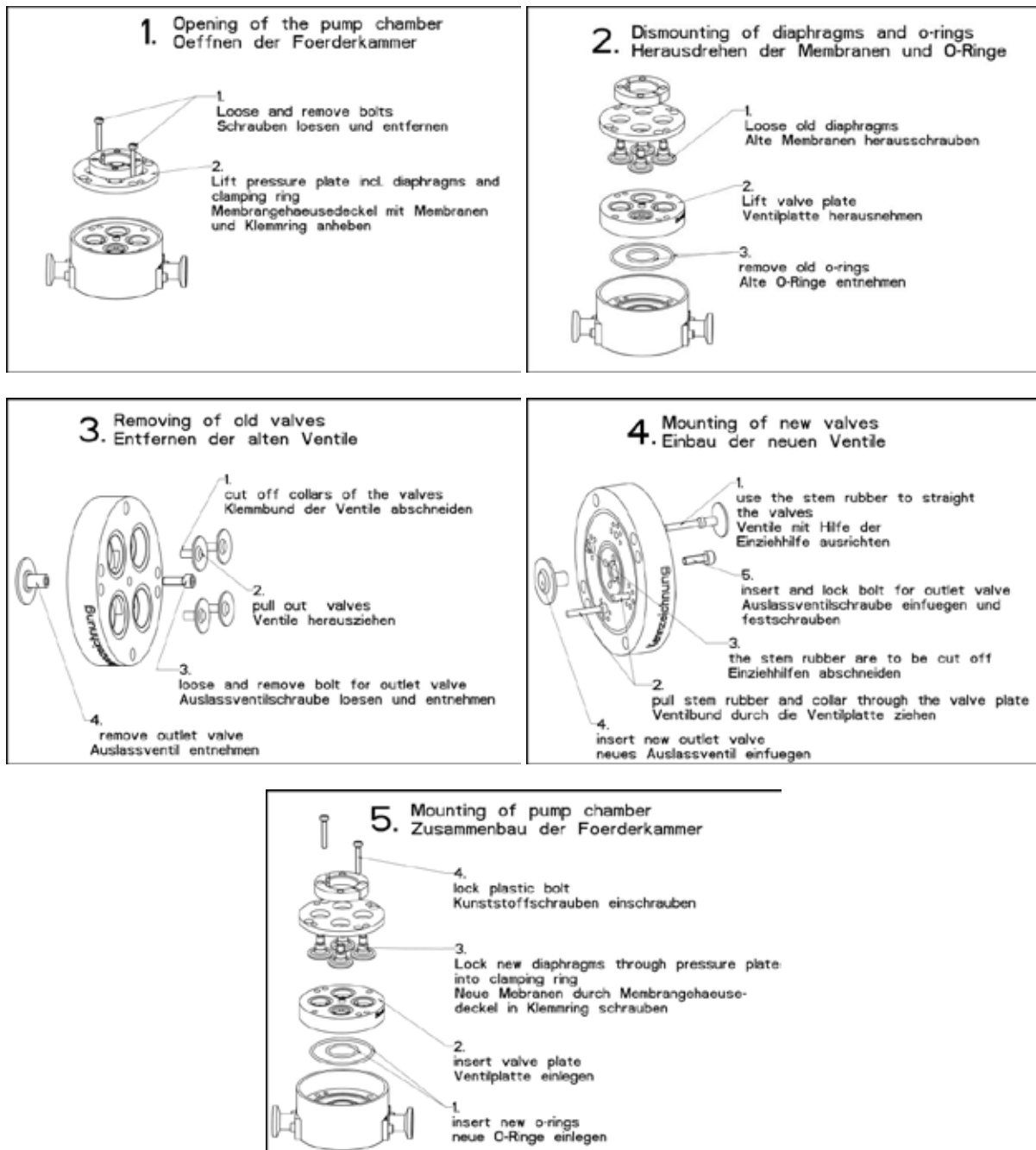

Torque value image 5 item 4: 2 Nm (1.5 lb-ft)

### 4.1.3. Assembly of the pump chamber to the ring drive

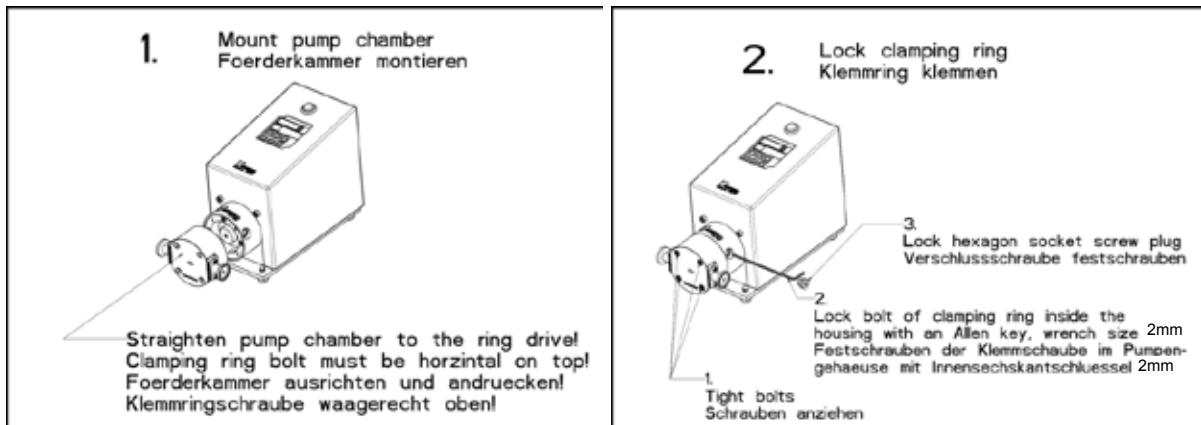

Pay attention to the following torque values:

Image 2 item 1: Bolts pump chamber 4 Nm (3 lb-ft)

Image 2 item 2: Bolt clamping ring 2 Nm (1.5 lb-ft)

## 4.2. Replacement bearing unit

The replacement of the bearing unit (shaft-bearing-cap unit, kit PSKITWLC155) can be conducted by the operator. The following drawings describe it step-by-step.

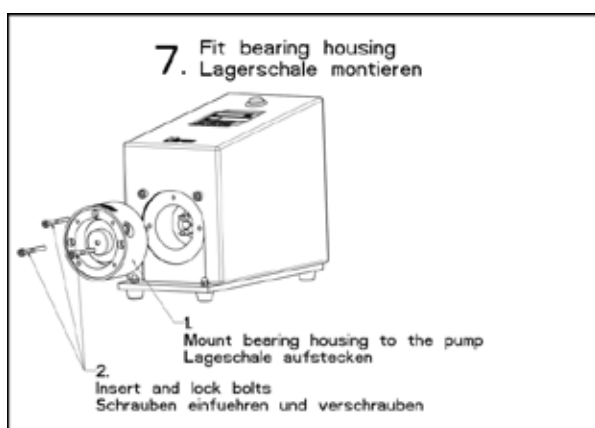
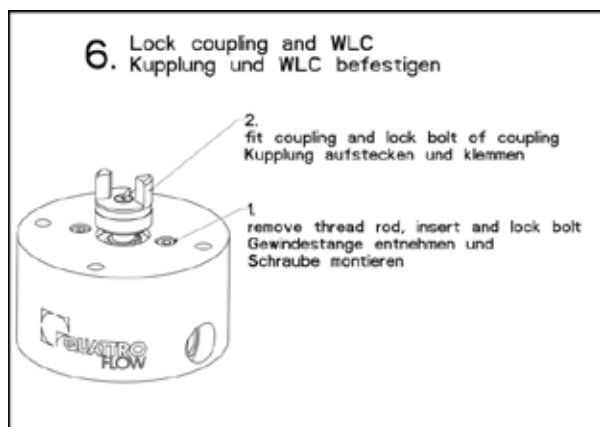
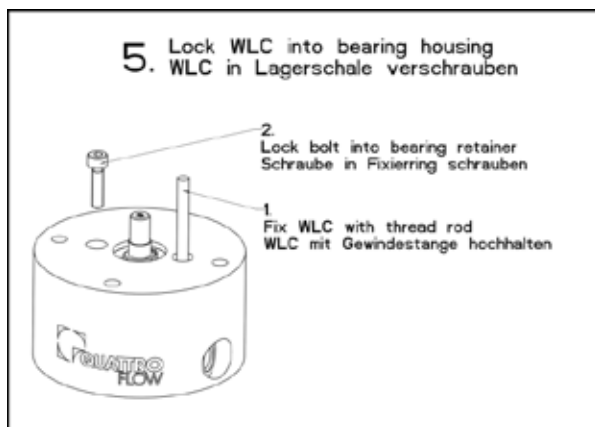
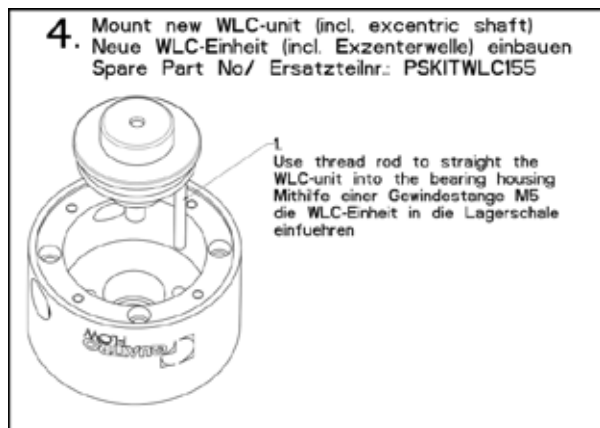
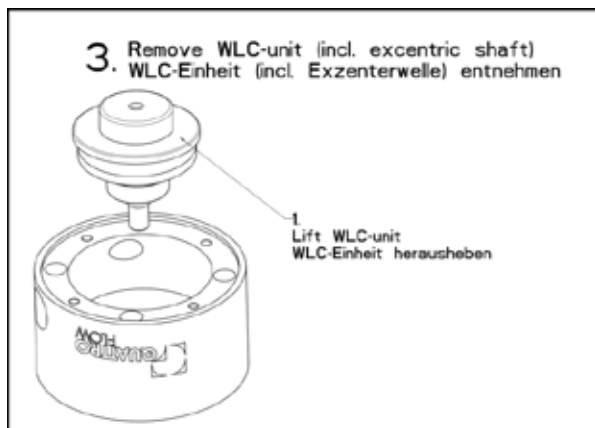
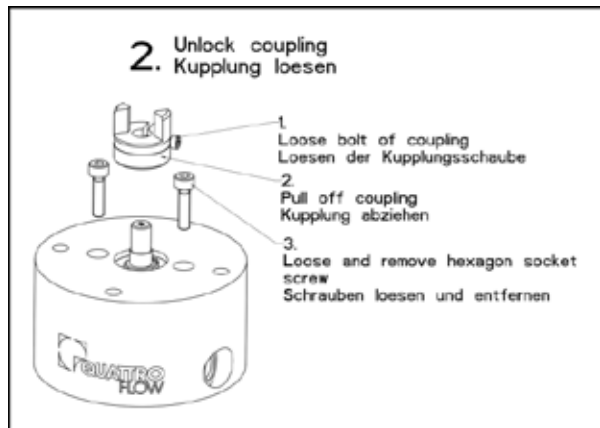
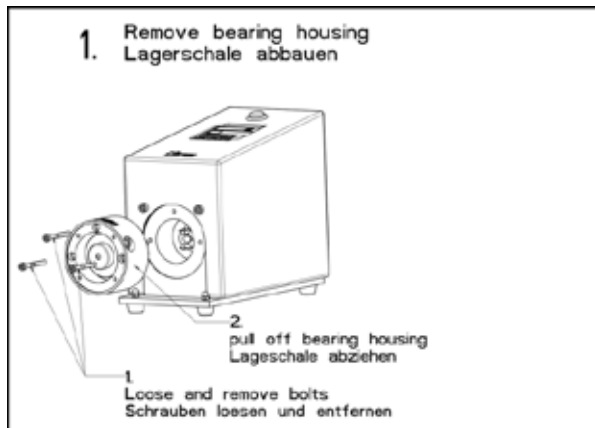

Between both coupling halves has to be a gap of 1 mm (0.039 inch).

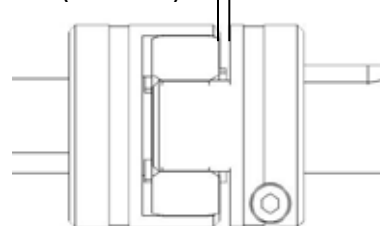

For further questions and ordering of spare parts please contact the manufacturer.



## 5. Operating troubles, causes and remedial action (Troubleshooting)

No.	Operating troubles									Causes and remedial action
	Pump does not start	Pump does not prime	Delivery is not obtained or reduced	Pressure head is not obtained	Irregular pump delivery	Pump operates noisily	Pump is leaky	Motor gets too warm	Display show Error code	
1		X					X			The screws of the pump-chamber maybe not tightened enough. Fix it!
2		X								Check the direction of flow showed by the arrow on the pump, in case of wrong way, turn the pump head.
3		X	X		X					Check suction pipeline and TC- seals for tightness.
4		X	X	X	X					Check suction head-increase suction line cross section.
5		X	X		X					Check viscosity of liquid pumped.
6	X								X	Check pump speed. Control speed of drive motor. Check voltage and frequency and the fuse (6,3A T in the control box)
7			X	X	X					Avoid air inclusions in the liquid to be pumped.
8			X		X					Check pressure head-open valve in discharge line completely, remove obstruction in discharge line.
9							X			Pressure line completely or partly clogged, diaphragm maybe broken, change diaphragm!
10			X							The diameter of the pipes in suction or pressure line are too small.
11						X				Check the coupling halves. They must be fixed with 1mm space.
12						X				Check longitudinal play of coupling rod pins. The spider might be worn.
13		X	X		X					Check whether foreign bodies in pump. Disassemble pump, remove foreign bodies, replace defective parts.
14	X							X	X	Pump stopped by the thermal circuit breaker. Please allow the motor to cool down – please reduce the power consumption.
15	X					X				Bearings are worn or defective Disassemble pump, replace the shaft – bearing – cap unit (PSKITWLC155)
16		X								The valves are dry (e.g. not in use for a long time), deformed or worn. Change valve or wet the pump.
17							X			The diaphragm is burst ( the discharge pressure was too high) – replace it PSKITQ15.
18		X	X	X			X			O–rings between valve plate and pump housing are defective PSKITQ12.
19						X				Align coupling accurately
20			X			X				The clamping ring screw got loose – fixe it!
21	X								X	Parameters of the control panel are wrong – check basic settings.
22							X			Pump after SIP cooled down too fast – slow cooling with room temperature

## 6. Performance charts of the QF 150S

Testmedia: Water at ambient temperature  
 Type of eccentric shaft: 5°  
 Discharge pressure: 0 to 6 bar (0 to 87 psi)

**Shows approximate flow rates as function of pump rpm.**

Please note:

Motor is directly coupled to pump: Pump rpm = motor rpm

Engine: Panasonic 90W (brushless)

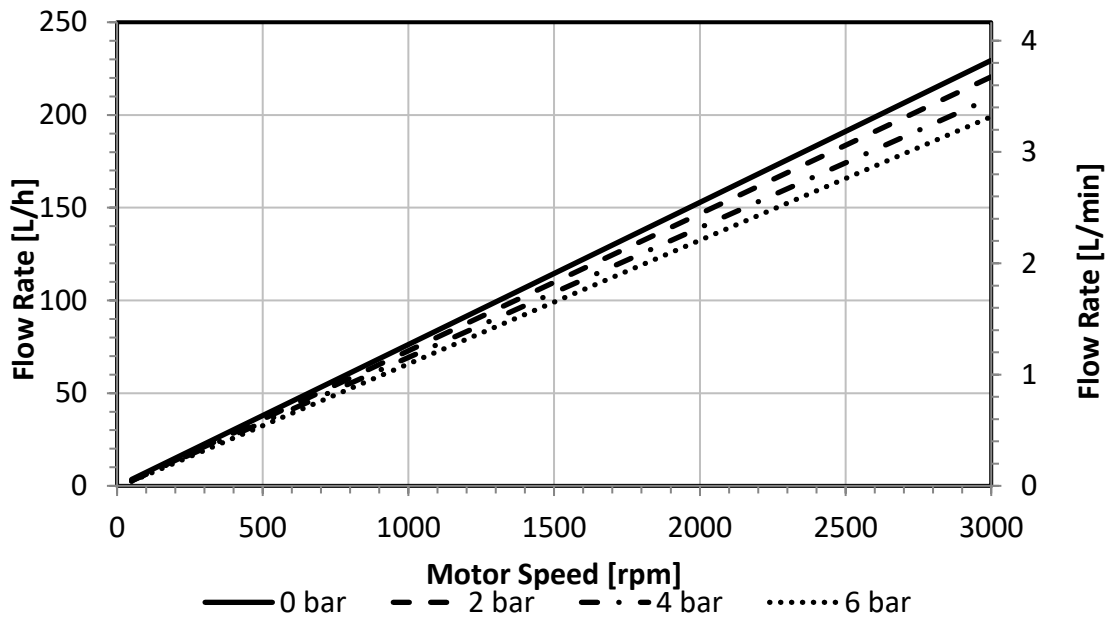

The flow rates showing at the chart above were ascertained with new diaphragms and new valves under standard conditions after the final assembly of the pump.

## 7. Technische Daten der QF 150S

Description	Unit	QF150S Standard Motor	QF150QCon
<b>Flow rate max.:</b>			
Eccentric shaft 3°	l/h (lpm)	100 (1.67)	100 (1.67)
Eccentric shaft 5°	l/h (lpm)	180 (3)	180 (3)
<b>Flow rate min.:</b>			
Eccentric shaft 3°	l/h (lpm)	1 (0.017)	1 (0.017)
Eccentric shaft 5°	l/h (lpm)	1 (0.017)	1 (0.017)
<b>Pressure:</b>			
Temperature of fluid < 40°C	bar (psi)	6 (87)	6 (87)
Temperature of fluid > 40°C	bar (psi)	4 (58)	4 (58)
<b>Temperature max.:</b>			
Fluid	°C (°F)	80 (176)	80 (176)
CIP	°C (°F)	90 (194)	90 (194)
SIP	°C (°F)	130 (260)	130 (260)
Autoclave	°C (°F)	130 (260)	130 (260)
<b>Suction lift dry at:</b>			
Eccentric shaft 3°	m (ft)	1-1,5 (3.2-4.9)	1-1,5 (3.2-4.9)
Eccentric shaft 5°	m (ft)	2-3 (6.6-9.8)	2-3 (6.6-9.8)
<b>Volume specifications:</b>			
Approximated volume per revolution at free output	ml	0,72 (3°) 1,2 (5°)	0,72 (3°) 1,2 (5°)
Filling volume without connectors	ml	15	15
Residual volume (after idle with high-speed motor)	ml	1-3	1-3
<b>Product wetted surface (approx.)</b>	cm <sup>2</sup> (inch <sup>2</sup> )	112 (17)	112 (17)
<b>Speed range pump</b>	rpm	10-3000	10-3000
<b>Connection specification inlet (standard)</b>			
Connector	"	1/4" TC	1/4" TC
Flange diameter	mm (inch)	25	25
Internal diameter	mm (inch)	4,7	4,7
<b>Connection specification outlet (standard)</b>			
Connector	"	1/4" TC	1/4" TC
Flange diameter	mm	25	25
Internal diameter	mm (inch)	4,7 (0.19)	4,7 (0.19)
Position of connectors		Inline	Inline
Number of flow directions		4	4
Diameter drive shaft	mm	7	7
<b>Product wetted materials (standard):</b>			
Pump housing		SS316L	SS316L
Valve plate		SS316L	SS316L
Diaphragms		Santoprene	Santoprene
Valves		EPDM	EPDM
O-rings		EPDM	EPDM
<b>Non-product wetted materials (standard):</b>			
Pump housing		SS316L	SS316L
Bearing housing		SS316L	SS316L
Base plate		SS316	SS316
Hood		SS316	SS316
<b>Dimensions pump with motor and housing:</b>			
Length	mm (inch)	257 (10,2)	277 (10-91)
Width	mm (inch)	164 (6,5)	200 (7,87)
Height	mm (inch)	185 (7,2)	195 (7,67)
<b>Weight pump with motor and housing</b>	kg (lb)	9,8 (22)	11,2 (25)
<b>IP protection class pump</b>	IP	54	54
<b>Operating temperature range</b>	°C (°F)	0...40 (32...104)	10...30 (50...86)

Operation humidity		30...85% (non-condensing)	30...75% (non-condensing)
Storage and transportation temperature range	°C (°F)	-20...60 (-4...140)	-10...55 (14...131)
Storage and transportation humidity		10...85% (non-condensing)	10...85% (non-condensing)
Custom tariff number		84138100	84138100

Description	Unit	QF150S Standard Motor		QF150QCon	
<b>Certificates/proofs (optional):</b>					
Elastomere (product wetted)		USP <87>, USP<88> Cl. VI; FDA21CFR177; BSE/TSE Safe		USP <87>, USP<88> Cl. VI; FDA21CFR177; BSE/TSE Safe	
Stainless steel parts (product wetted)		3.1; Surface roughness; Ferrite (EN10204)		3.1; Surface roughness; Ferrite (EN10204)	
<b>Motor/Gear:</b>					
Manufacturer (standard)		Panasonic		Panasonic	
Type		MBMU9A1AS	MBMU9A2AS	MBMU9A1AS	MBMU9A2AS
Rated speed	min-1	3000		3000	
Voltage	V	100	200	100	200
Ampacity	A	2,2	1,1	2,2	1,1
Power	KW	0,09		0,09	
Shaft diameter	mm	12		12	
IP protection class	IP	65		65	
Color	RAL	black		black	
Forced ventilation in hood		no		no	
Coupling		claw-coupling KTR (Rotex)		claw-coupling KTR (Rotex)	
Gear ratio		n/a		n/a	
<b>Additional information controller:</b>					
Type		Control integrated in the housing		Control integrated in the housing	
Main voltage	V	100...120	200...240	100...120	200...240
rated capacity	W	250		300	
Nominal frequency	Hz	50-60			
rated current	A	2,2	1,1	2,6	1,3
Network shape		TN-S			
Mains supply		1P+N+E			
protection level	A	10			
length, cross-section of the power cord	m, mm <sup>2</sup> (ft, AWG)	3, 3x1 (9.8, 3x17)	3, 3x2,08 (9.8, 3x14)	3, 3x1 (9.8, 3x17)	3, 3x2,08 (9.8, 3x14)
Connection of supply voltage		NEMA 5-15 (US)	Schukostecker (EU), BS1363 (UK)	NEMA 5-15 (US)	Schukostecker (EU), BS1363 (UK)
Analog input (included)		0-5V, RS485		0-10V, 4-20 mA	
Modbus-port		/		RS485	
IP protection class		see IP protection class pump			

All technical data relate to a Quattroflow pump in the standard version. Special designed pumps (e.g. special product connections) may have different data that can be found in the advanced documentation for each Quattroflow pump.

Quattroflow is a brand of PSG Germany GmbH.

PSG Germany is constantly working on improvements of the pump. Modifications of the design or materials might be done without prior notice.



Subject to change without notice, 2021-10 (replaces 2020-10)

**PSG Germany GmbH**  
**Hochstraße 150-152 · D-47228 Duisburg, Germany**  
**Telefon +49 (0) 2065 89205-0 · Fax +49 (0) 2065 89205-40**  
**[www.quattroflow.com](http://www.quattroflow.com) · [psg-germany@psgdover.com](mailto:psg-germany@psgdover.com)**